

Features

- 36-inch minimum base cabinet width.
- Double equal bowls.
- 9-inch depth.
- Five oversized faucet holes.
- Oversized holes allow for easy installation of faucets and accessories.
- Rear drain increases workspace in the sink and storage space underneath.
- Includes cutout template.

Material

- KOHLER® enameled cast iron.

Installation

- Under-mount

Recommended Products/Accessories

K-9000 P-Trap
K-6121 Left-Bowl Sink Rack
K-6122 Right-Bowl Sink Rack
K-6377 Sponge Caddy
K-6378 Kitchen Brush Caddy
K-6379 Kitchen Squeegee
K-6382 Disinfecting Wipes Dispenser
K-6383 Soap Dispenser
K-8618 Paper Towel Holder
K-8619 Flexible Kitchen Mat
K-8624 Dish Scraper
K-8801 Sink Strainer
K-8799 Sink Strainer

Optional Products/Accessories

K-6545 Sponge Caddy

Included Components

Additional Components:
Under-mount sink kit 23" (584 mm)



Codes/Standards

















ASME A112.19.1/CSA B45.2

KOHLER® Enameled Cast Iron Kitchen Sink Lifetime Limited Warranty

See website for detailed warranty information.

Available Colors/Finishes

Color tiles intended for reference only.

Color	Code	Description
	0	White
	FF	Sea Salt™
	96	Biscuit
	47	Almond
	FD	Cane Sugar™
	NY	Dune
	95	Ice™ Grey
	G9	Sandbar
	33	Mexican Sand™
	K4	Cashmere
	FT	Basalt
	58	Thunder™ Grey
	20	Suede
	KA	Black 'n Tan
	FP	Caviar
	7	Black Black™

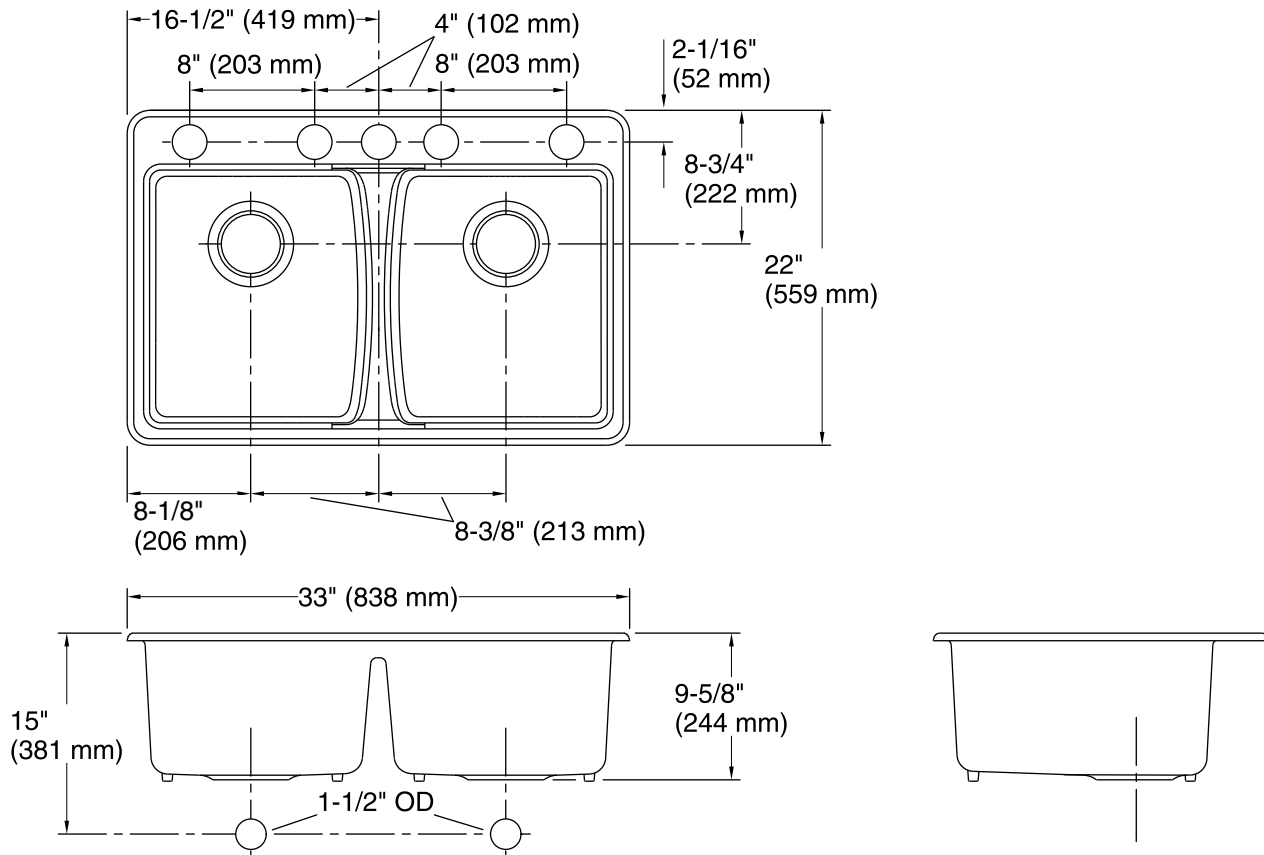

Technical Information

All product dimensions are nominal.

Bowl configuration: Double equal

Installation: Under-mount

Min. base cabinet width: 36" (914 mm)

Bowl area (Left): Length: 14-1/4" (362 mm)
Width: 16-9/16" (421 mm)
Bowl depth: 9" (229 mm)

Bowl area (Right): Length: 14-1/4" (362 mm)
Width: 16-9/16" (421 mm)
Bowl depth: 9" (229 mm)

Number of deck holes: 5

Faucet hole(s): 2-3/8" (60 mm)

Drain hole: 3-7/8" (98 mm)

Template: 1171757-7, required, included

Notes

Install this product according to the installation instructions.

NOTICE: Countertop manufacturer or cutter must use the cutout template provided with the product, or a current one provided by Kohler Co. (call 1-800-4-KOHLER). Kohler Co. is not responsible for cutout errors when the incorrect cutout template is used.